

# P & M<sup>®</sup> SLF610

## Slide and Fold Glass Panel System

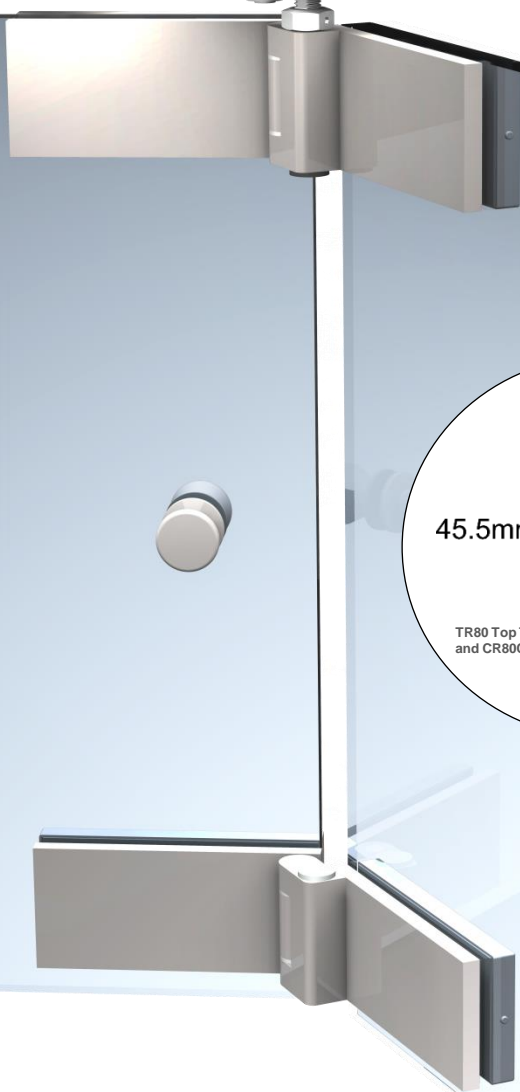
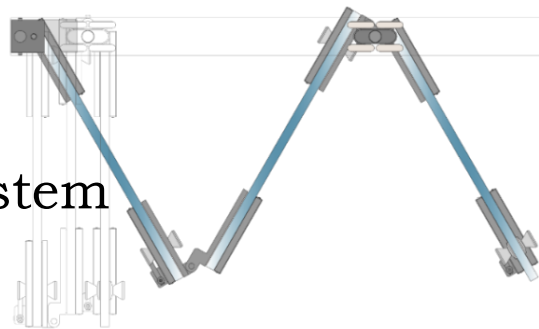

### Specification Guidelines:

- Maximum panel weight: 60kg
- Maximum panel width :
  - 10mm thick glass – 850mm
  - 12mm thick glass – 750mm
- Maximum panel height: 2700mm
- Optional floor track

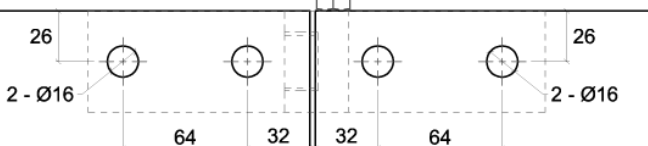
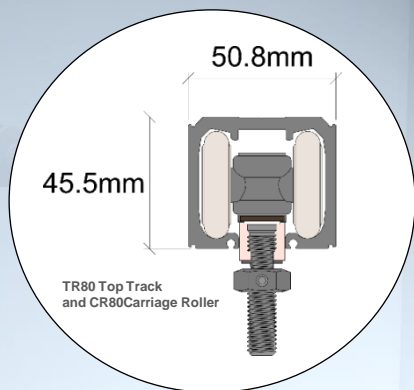

3mm  
Glass to Glass Gap

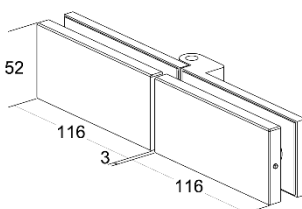
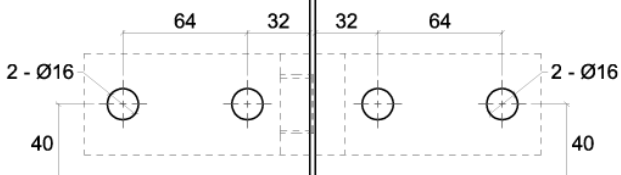

HN610-2 Hinge

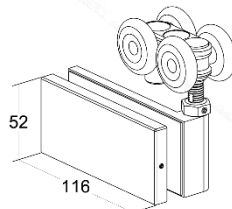

HR610-1 Roller Hinge